

! INFO !

- (DE) Die Batterie des Zugfahrzeugs bzw. gezogenen Fahrzeugs nicht direkt über die Steckdose aufladen.
- (FR) Ne pas charger les batteries du véhicule tracteur et/ou tracté directement sur la prise de courant.
- (NL) De accu van het trekkend voertuig c.q. getrokken voertuig niet rechtstreeks via de contactdoos opladen.
- (GB) Do not charge the battery of the towing vehicle and/or towed vehicle directly via the socket.
- (ES) No recargue la batería del vehículo remolque y/o del remolcado directamente mediante el enchufe.
- (IT) Non caricare la batteria del veicolo trainante o di quello trainato direttamente dalla presa.
- (SE) Ladda inte batteriet i det bogserande fordonet och/eller det bogserade fordonet direkt via kontakten.
- (CZ) Nenabíjajte baterii tažného ani taženého vozidla přes zásuvku.
- (DK) Oplad ikke bugseringskøretøjet og/eller det bugserede køretøjs batteri direkte v.h.a. stikdåsen.
- (FI) Älä lataa hinaavan ajoneuvon ja/tai hinattavan ajoneuvon akkuja suoraan pistorasian kautta.
- (GR) Μη φορτίσετε την μπαταρία του ρυμουλκούμενου οχήματος και/ή ρυμουλκημένου οχήματος απευθείας μέσω του ρευματοδότη.
- (NO) Batteriet til kjøretøyet som trekker eller blir trukket skal ikke lades direkte via koblingsboksen.
- (PL) Nie ładować akumulatora pojazdu holującego/holowanego bezpośrednio przez gniazdo.

- (DE) Gebrauchsanleitung
(FR) Mode d'emploi
(NL) Gebruikershandleiding
(GB) User guide
(ES) Guía del usuario
(IT) Manuale di istruzioni
(SE) Bruksanvisning
(CZ) Uživatelská příručka
(DK) Brugervejledning
(FI) Käyttöohjeet
(GR) Οδηγός χρήστη
(NO) Brukerveiledning
(PL) Instrukcja obsługi

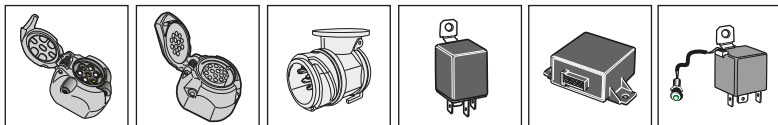
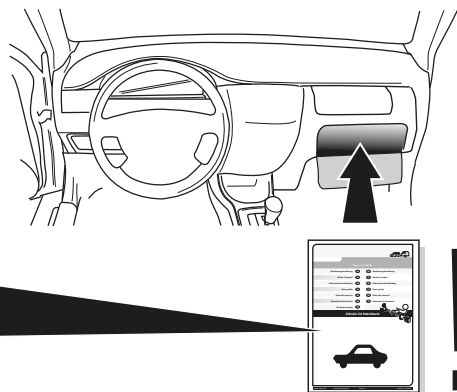

SPARE PARTS

www.ecs-electronics.com

ECS

ELECTRONICS



Partnr.: NI-066-DL

Gebrauchsanleitung (DE)

(CZ) Uživatelská příručka

Mode d'emploi (FR)

(DK) Brugervejledning

Gebruikershandleiding (NL)

(FI) Käyttöohjeet

User guide (GB)

(GR) Οδηγός χρήστη

Guía del usuario (ES)

(NO) Brukerveiledning

Manuale di istruzioni (IT)

(PL) Instrukcja obsługi

Bruksanvisning (SE)

Nissan NV200 10/2009 >>
Nissan e-NV200 04/2017 >>

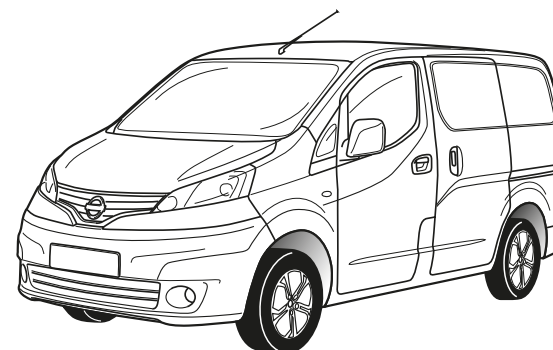
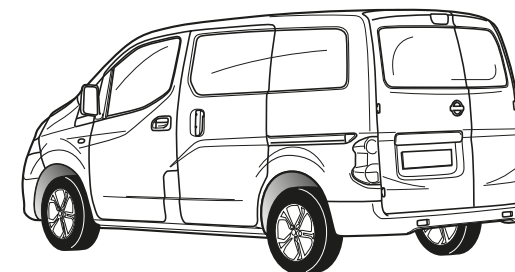
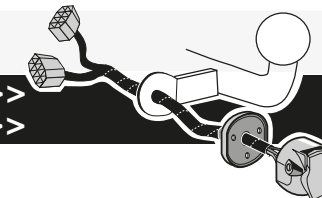

- DE Anschluss Steckdose
- FR Connection de la prise
- NL Contactdoos aansluiting
- GB Socket connection
- ES Conexión de la caja de enchufe
- IT Allaccio zoccolo
- SE Anslutning kontaktdosa
- CZ Objímkový konektor
- DK Stikdåse forbindelse
- FI Pistorasia liitäntä
- GR Υποδοχή σύνδεσης
- NO Tilkobling koblingsboks
- PL Połączenie przez gniazdo

DIN/ISO 11446	1/L	2	2a	1-8	4/R	5/58-R	6/54	7/58-L	8	9	10	10	11	12	13
Pmax	21W	2x21W	Grau	Weiß	Grün	Braun	Rot (1,00mm ²)	Schwarz	Schwarz/ Rot	Braun/ Weiß	Rot (2,50mm ²)	180W/15Amp	Weiß	-	13
DE	Gelb	Blau	Grau	Weiß	Grün	Braun	Rot (1,00mm ²)	Schwarz	Schwarz/ Rot	Braun/ Weiß	Rot (2,50mm ²)	180W/15Amp	Weiß	-	13
FR	Jaune	Bleu	Gris	Blanc	Vert	Marron	Rouge (1,00mm ²)	Noir	Noir/ Rouge	Marron/ Blanc	Rouge (2,50mm ²)	180W/15Amp	Blanc	-	13
NL	Geel	Blauw	Grijs	Wit	Groen	Bruin	Rood (1,00mm ²)	Zwart	Zwart/ Rood	Bruin/ Wit	Rood (2,50mm ²)	180W/15Amp	Wit	-	13
GB	Yellow	Blue	Grey	White	Green	Brown	Red (1,00mm ²)	Black	Black/ Red	Brown/ White	Red (2,50mm ²)	180W/15Amp	White	-	13
ES	Amarillo	Azul	Gris	Blanco	Verde	Marrón	Rojo (1,00mm ²)	Negro	Negro/ Rojo	Marrón/ Blanco	Rojo (2,50mm ²)	180W/15Amp	Blanco	-	13
IT	Giallo	Blu	Grigio	Bianco	Verde	Marrone	Rosso (1,00mm ²)	Nero	Nero/ Rosso	Marrone/ Bianco	Rosso (2,50mm ²)	180W/15Amp	Bianco	-	13
SE	Gul	Blå	Grå	Vit	Grön	Brun	Röd (1,00mm ²)	Svart	Svart/ Röd	Brun/ Vit	Röd (2,50mm ²)	180W/15Amp	Vit	-	13
CZ	Žlutá	Modrá	Šedá	Bílá	Zelená	Hnědá	Červená (1,00mm ²)	Černá	Černo/ Červená	Hnědo/ Bílá	Červená (2,50mm ²)	180W/15Amp	Bílá	-	13
DK	Gul	Blå	Grå	Hvid	Grøn	Brun	Rød (1,00mm ²)	Sort	Sort/ Rød	Brun/ Hvid	Rød (2,50mm ²)	180W/15Amp	Hvid	-	13
FI	Keltainen	Sininen	Harmaa	Valkoinen	Vihreä	Ruskea	Punainen (1,00mm ²)	Musta	Musta/ Punainen	Ruskea/ Valkoinen	Punainen (2,50mm ²)	180W/15Amp	Valkoinen	-	13
GR	Κίτρινο	Μπλε	Γκρι	Λευκό	Πράσινο	Καφέ	Κόκκινο (1,00mm ²)	Μαύρο	Μαύρο/ Κόκκινο	Καφέ/ Λευκό	Κόκκινο (2,50mm ²)	180W/15Amp	Λευκό	-	13
NO	Gul	Blå	Grå	Hvit	Grønn	Brun	Rød (1,00mm ²)	Svart	Svart/ Rød	Brun/ Hvit	Rød (2,50mm ²)	180W/15Amp	Hvit	-	13
PL	Żółty	Niebieski	Szary	Biały	Zielony	Brązowy	Czerwonony (1,00mm ²)	Czarny	Czarny/ Czerwonony	Brązowy/ Biały	Czerwonony (2,50mm ²)	180W/15Amp	Biały	-	13

- DE Sicherungen austauschen
- FR Remplacer les fusibles
- NL Zekeringen vervangen
- SE Byte av säkringar
- CZ Výměna pojistky
- DK Udsiftning af sikringer
- FI Vaihdta varokkeet
- GR Αλλαγή ασφάλειας
- NO Skifte sikringene
- PL Wymienić bezpieczniki

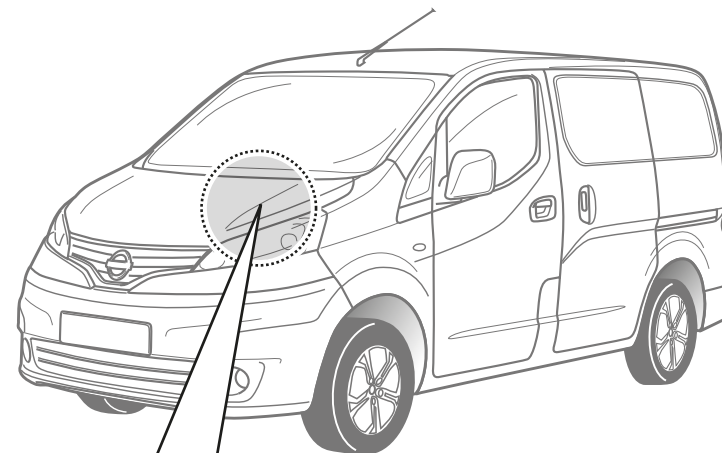

- DE Braun/Weiß
- FR Marron/Blanc
- NL Bruin/Wit
- GB Brown/White
- ES Marrón/Blanco
- IT Marrone/Bianco
- SE Brun/Vit
- CZ Hnědo/Bílá
- DK Brun/Hvid
- FI Ruskea/Valkoinen
- GR Καφέ/Λευκό
- NO Brun/Hvit
- PL Brązowy/Biały

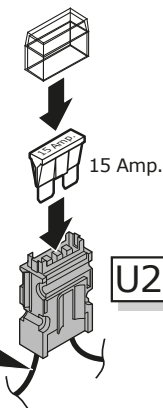
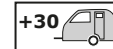

INFO : Storage

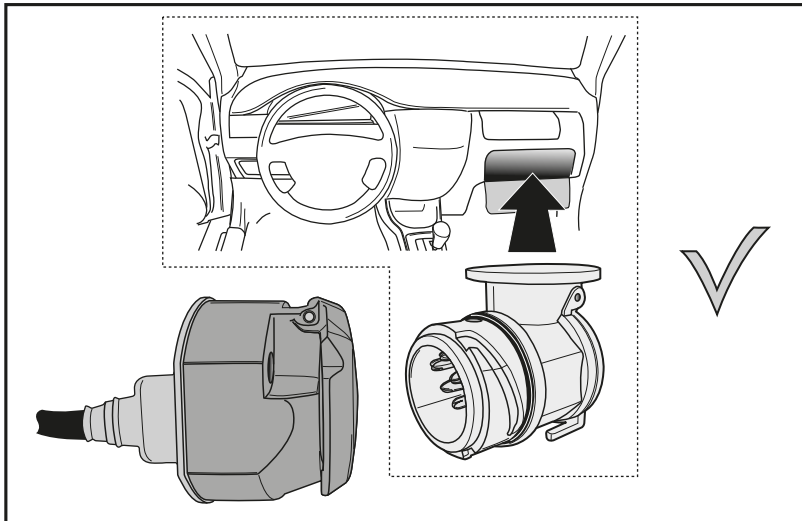
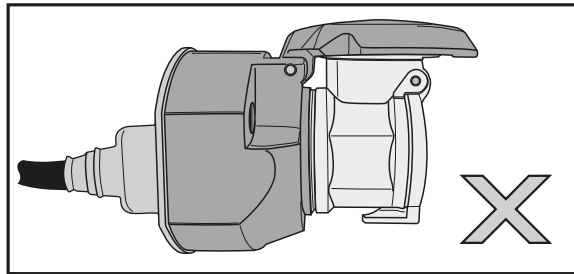
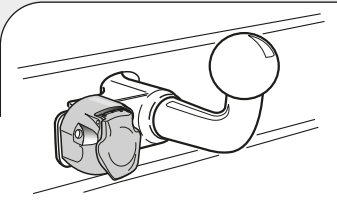
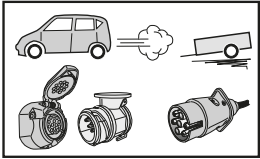

INFO

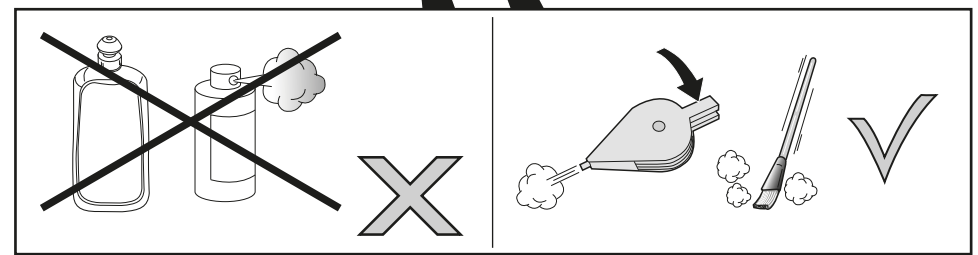
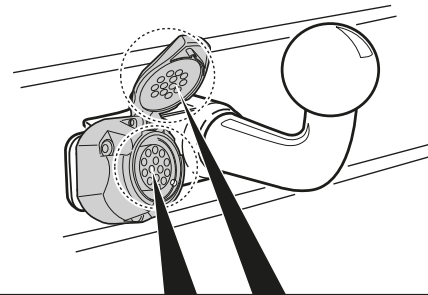
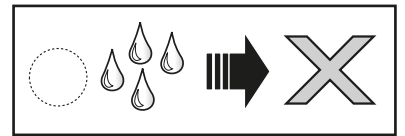
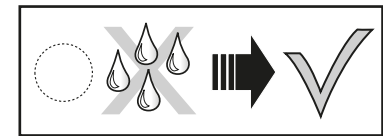
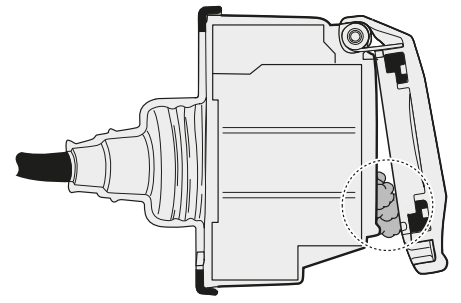
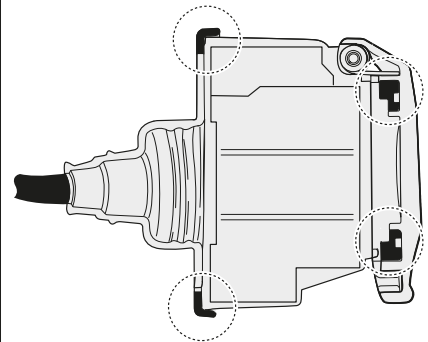
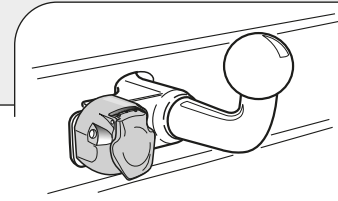
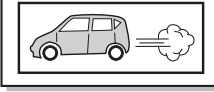

INFO : Ring.

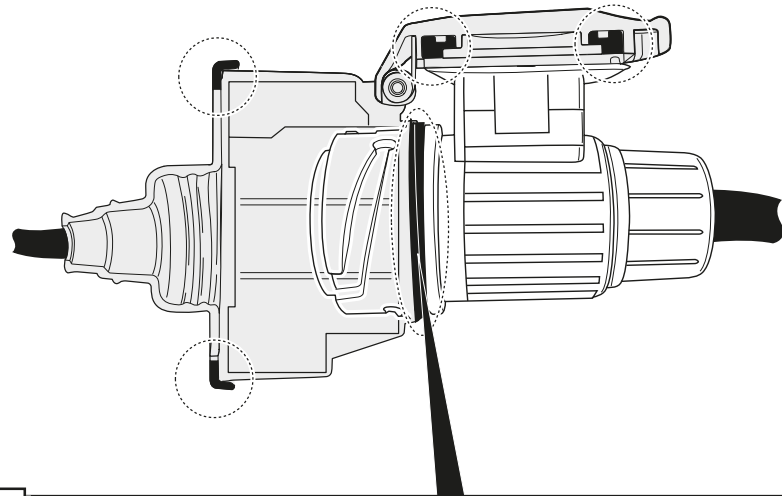
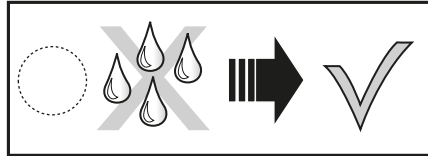
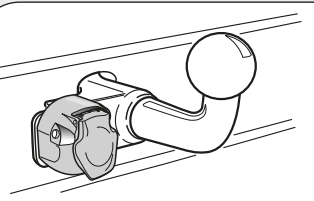
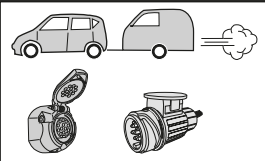

INFO

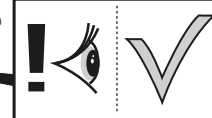
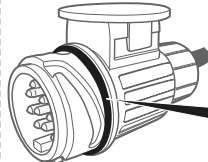
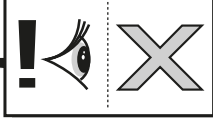
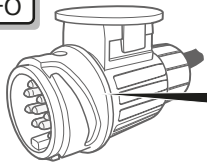

INFO : Adapt.

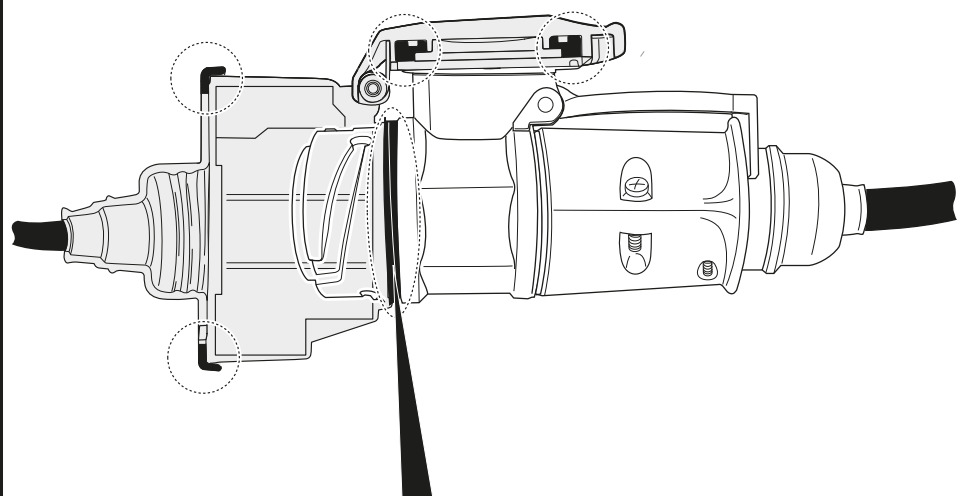
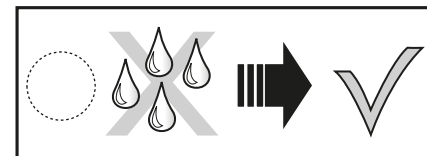
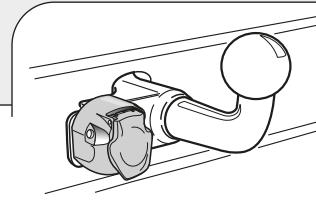
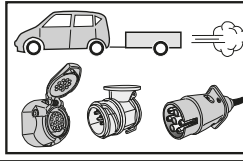

INFO

